

WITH HARDENED AND GROUND TOOTHING. BY ACTING ON AN ECCENTRIC PIN, THE TOOL HOLDER IS LOCKED ON THE TOOTHING OF THE BODY. IT...

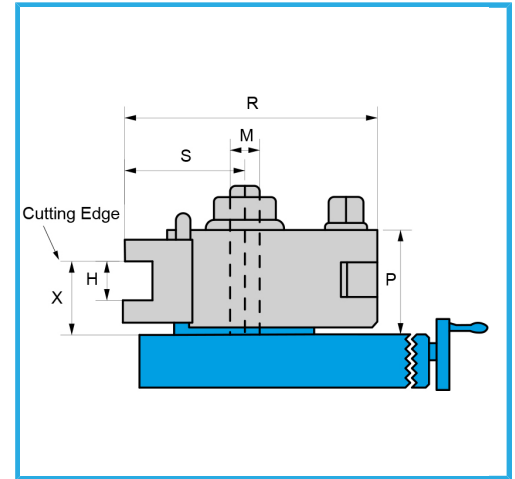

R max	125 mm
S max	68 mm
P	60 mm
h	20 mm
X min	35 mm
M	13 mm
Gross weight	8,47 kg
Packaging dimensions	280x280x120 h mm
EAN Code	8012667179397



Box