

POSITIVE.

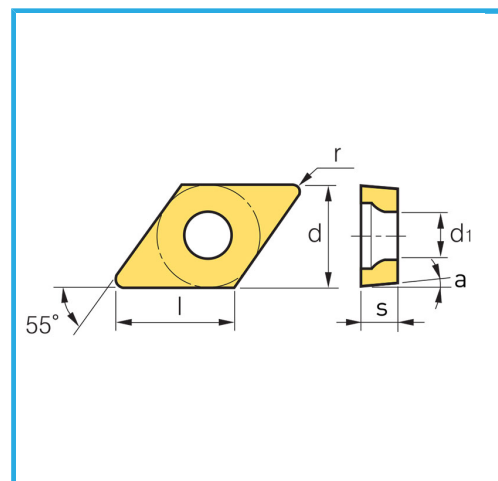

Dimensions	11 mm
d	9,52 mm
l	11,6 mm
s	3,97 mm
r	0,4 mm
d1	2,2 mm
a°	7°
Pack	10
Gross weight	0,06 kg
EAN Code	8012667011284



Box



-