

POSITIVE.

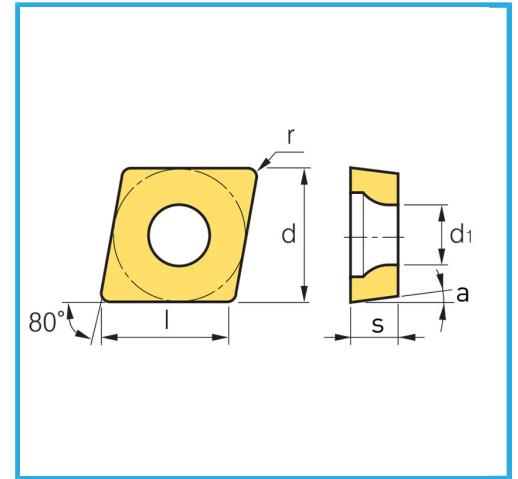

Dimension	9 mm
d	9,52 mm
l	9,7 mm
s	3,97 mm
r	0,4 mm
d1	4,4 mm
a°	7°
Pack	10
Gross weight	0,01 kg
EAN Code	8012667359652

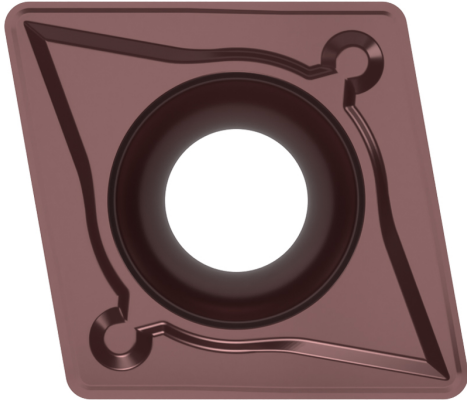

Box

