

POSITIVE.

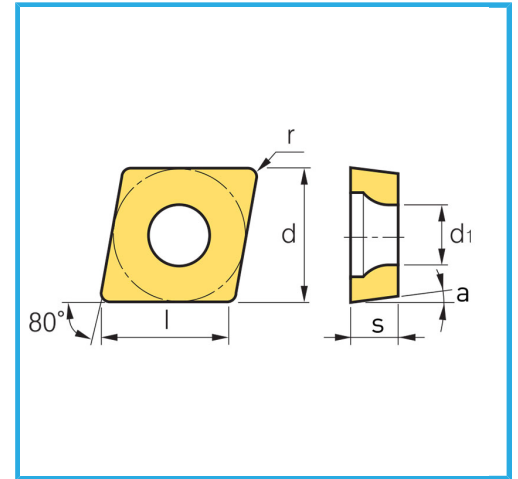

Dimension	6 mm
d	6,35 mm
l	6,3 mm
s	2,38 mm
r	0,4 mm
d1	2,8 mm
a°	7°
Pack	10
Gross weight	0,00 kg
EAN Code	8012667011208

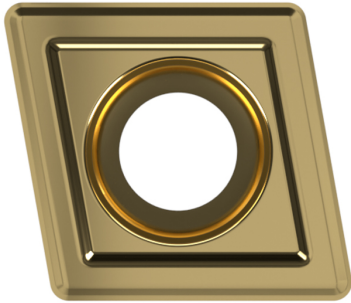

Box

