

INSERT INCLUDED, USEFUL FOR HAVING A SET THAT ALLOWS YOU TO PERFORM MOST TURNING OPERATIONS WITH SMALL LATHES.

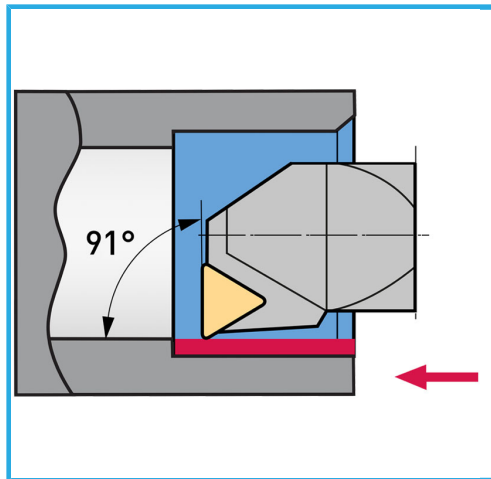

Ext. shank / Insert

Int. shank / Insert

Length

Screw

Gross weight

Packaging dimensions

EAN Code

10 mm / TCMT110204...

8 mm / TCMT090204...

Ext: 63 mm / Int: 100 mm

KV250

0,44 kg

150x145x40 h mm

8012667183417



Box



Burnished



External